

# Specifications

备注(Remark)

1. 材料(MATERIAL)

胶芯: PA6T/PBT+30%G.F UL94V-0, 颜色: 黑色.

Housing: PA6T/PBT+30%G.F UL94V-0, Color: Black

端子: 磷/青铜, 镍底30u"MIN, 表面镀金u"MIN

Contact: Phosphor bronze, 1u"MIN GOLD PLATING OVER ALL  
30u" MIN NICKEL UNDERPLATING OVER ALL

2. 特性 (characteristics):

额定电流: 2 AMP

Rating Current: 2 AMP.

接触阻抗: 20 mΩ MAX.

Contact Resistance: 20 mΩ MAX.

绝缘阻抗: 1000 MΩ MIN.

Insulating Resistance: 1000 MΩ MIN.

耐电压: AC 500V.

Withstanding Voltage: AC 500V.

温度范围: -40°C to +105°C

Temperature Range: -40°C to +105°C

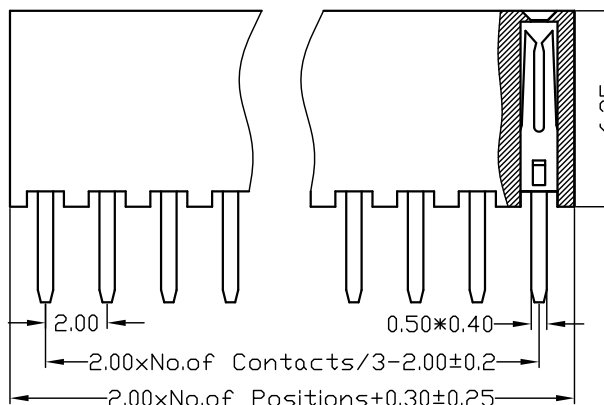
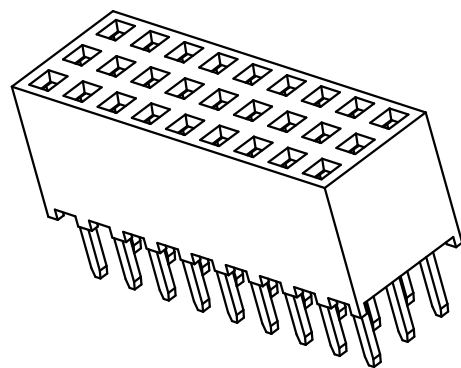
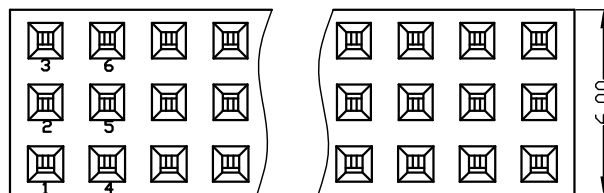
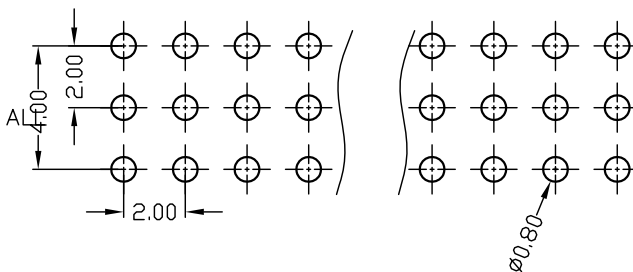

# Ordering Information

F263-13 XX XX X SY

NO. OF PINS PER ROW 3-40P	Contact Plating Full Of Gold	Semi-gold	INSULATOR MATERIAL:	PACKING
A0=0.8u"	B0=0.8U"	A: PBT	A: PE Bag	
A1=1u"	B1=1U"	B: PA6T	B: Tape & Reel	
A2=1.5u"	B2=1.5U"	C: PA9T	C: Tube	
A3=2u"	B3=2U"	D: LCP	D: Tube+CAP	
A4=3u"	B4=3U"		E: Tray	
A5=5u"	B5=5U"			
A6=10u"	B6=10U"			
A7=15u"	B7=15U"			
A8=20u"	B8=20U"			
A9=30u"	B9=30U"			
S1=Ordinary Tin Plated				
S2=Matte Tin Plated				
S3=Tin-plated High-temperature				

上海高霖电子有限公司

REV	DATE	MODIFICATION DESCRIPTION	CHANGE	APPROVE	DIM	TOL	OPERATION	SCALE	Fit	上海高霖电子有限公司			
					X.X	±0.25		UNIT	MM				
					X.XX	±0.20		SIZE	A4	DESIGN	卢小强	PART NO.	F263-13XXXXXXSYX1
					X.XXX	±0.10		SHEET	1/1	CHECK		TITLE:	2.0mm 排母 三排 塑高6.35 180度 Y型
					Angle	±3°		PROJ.	APPROVE		Customer No.		

# Specifications

备注(Remark)

1. 材料(MATERIAL)

胶芯: PA6T/PBT+30%G.F UL94V-0, 颜色: 黑色.

Housing: PA6T/PBT+30%G.F UL94V-0, Color: Black

端子: 磷/青铜, 镍底30u"MIN, 表面镀金u"MIN

Contact: Phosphor bronze, 1u"MIN GOLD PLATING OVER 30u" MIN NICKEL UNDERPLATING OVER ALL

2. 特性 (characteristics):

额定电流: 2 AMP

Rating Current: 2 AMP.

接触阻抗: 20 mΩ MAX.

Contact Resistance: 20 mΩ MAX.

绝缘阻抗: 1000 MΩ MIN.

Insulating Resistance: 1000 MΩ MIN.

耐电压: AC 500V.

Withstanding Voltage: AC 500V.

温度范围: -40°C to +105°C

Temperature Range: -40°C to +105°C

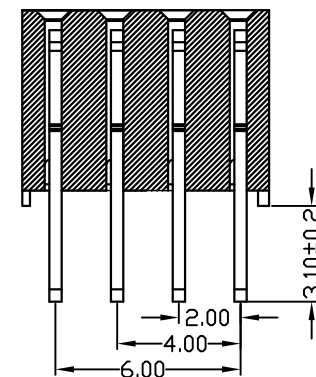
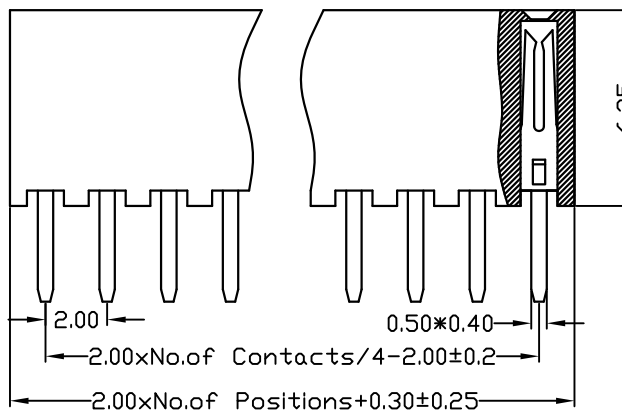
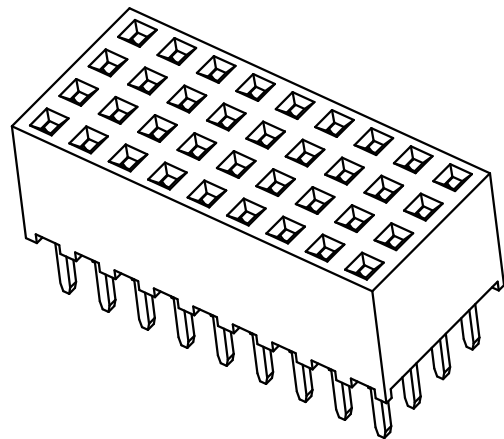
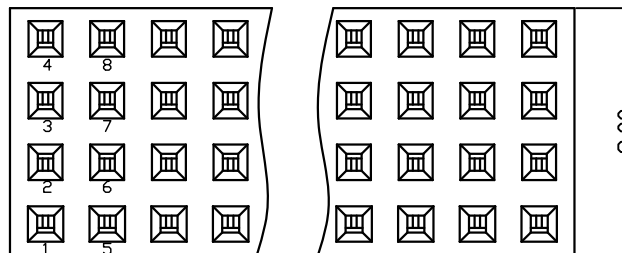
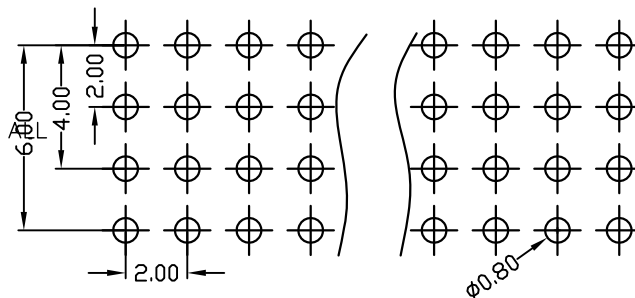

# Ordering Information

F263-14 XX XX X SY

NO. OF PINS PER ROW 4-40P	Contact Plating Full Of Gold	Semi-gold	INSULATOR MATERIAL:	PACKING
A0=0.8u"	B0=0.8U"	A: PBT	A: PE Bag	
A1=1u"	B1=1U"	B: PA6T	B: Tape & Reel	
A2=1.5u"	B2=1.5U"	C: PA9T	C: Tube	
A3=2u"	B3=2U"	D: LCP	D: Tube+CAP	
A4=3u"	B4=3U"		E: Tray	
A5=5u"	B5=5U"			
A6=10u"	B6=10U"			
A7=15u"	B7=15U"			
A8=20u"	B8=20U"			
A9=30u"	B9=30U"			
	S1=Ordinary Tin Plated			
	S2=Matte Tin Plated			
	S3=Tin-plated High-temperature			

上海高霖电子有限公司

REV	DATE	MODIFICATION DESCRIPTION	CHANGE	APPROVE	DIM	TOL	OPERATION	SCALE	Fit	上海高霖电子有限公司				
					X.X	±0.25		UNIT	MM					
					X.XX	±0.20		SIZE	A4	DESIGN	卢小强	PART NO.	F263-14XXXXXXSYX1	
					X.XXX	±0.10		SHEET	1/1	CHECK		TITLE:	2.0mm 排母 四排 塑高6.35 180度	
					Angle	±3°		PROJ.	☉	APPROVE		Customer No.		

# Specifications

备注(Remark)

1. 材料(MATERIAL)

胶芯: PA6T/PBT+30%G.F UL94V-0, 颜色: 黑色.

Housing: PA6T/PBT+30%G.F UL94V-0, Color: Black

端子: 磷/青铜, 镍底30u"MIN, 表面镀金u"MIN

Contact: Phosphor bronze, 1u"MIN GOLD PLATING OVER ALL  
30u" MIN NICKEL UNDERPLATING OVER ALL

2. 特性 (characteristics):

额定电流: 2 AMP

Rating Current: 2 AMP.

接触阻抗: 20 mΩ MAX.

Contact Resistance: 20 mΩ MAX.

绝缘阻抗: 1000 MΩ MIN.

Insulating Resistance: 1000 MΩ MIN.

耐电压: AC 500V.

Withstanding Voltage: AC 500V.

温度范围: -40°C to +105°C

Temperature Range: -40°C to +105°C

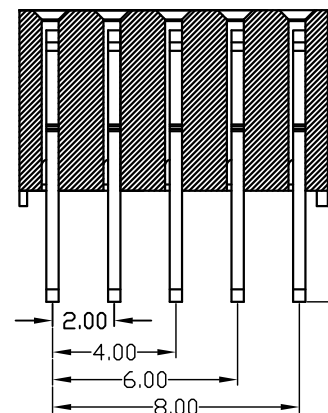
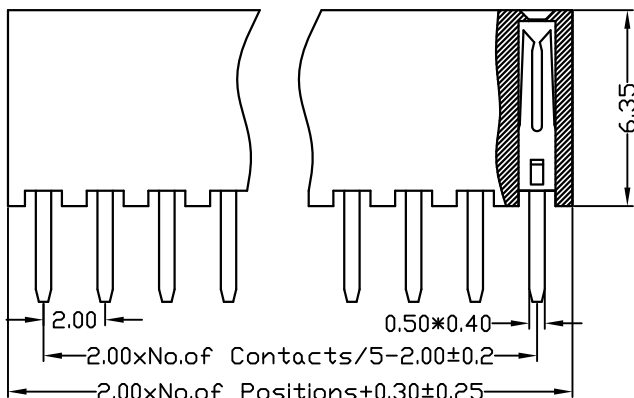
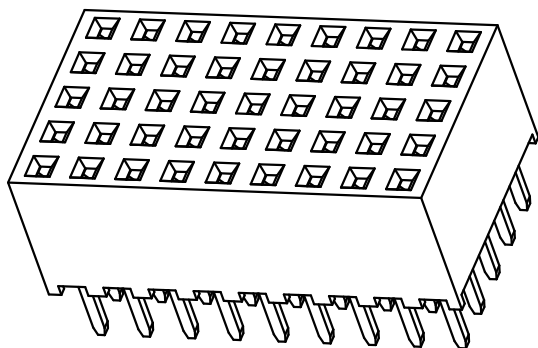
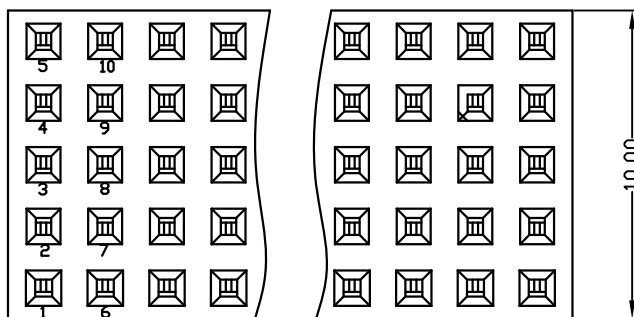
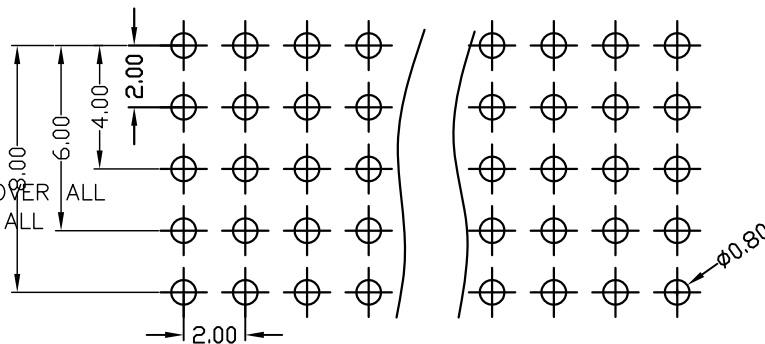

DIM "A"	2.4	2.8	3.1	5.2
"A"				

# Ordering Information

F263-15 XX XX X SY

NO. OF PINS PER ROW 5-40P	Contact Plating		INSULATOR	PACKING
	Full Of Gold	Semi-gold	MATERIAL:	A: PE Bag
A0=0.8u"	B0=0.8U"	A: PBT	B: Tape & Reel	
A1=1u"	B1=1U"	B: PA6T	C: Tube	
A2=1.5u"	B2=1.5U"	C: PA9T	D: Tube+CAP	
A3=2u"	B3=2U"	D: LCP	E: Tray	
A4=3u"	B4=3U"			
A5=5u"	B5=5U"			
A6=10u"	B6=10U"			
A7=15u"	B7=15U"			
A8=20u"	B8=20U"			
A9=30u"	B9=30U"			
	S1=Ordinary Tin Plated			
	S2=Matte Tin Plated			
	S3=Tin-plated High-temperature			

REV	DATE	MODIFICATION DESCRIPTION	CHANGE	APPROVE	DIM	TOL	OPERATION	SCALE	Fit
							X.X ±0.25	UNIT	MM
							X.XX ±0.20	SIZE	A4
							X.XXX ±0.10	SHEET	1/1
							Angle ±3°	PROJ.	CHECK
								APPROVE	

上海高霖电子有限公司

DESIGN	卢小强	PART NO.	F263-15XXXXXXSYX1
CHECK		TITLE:	2.0mm 排母 五排 塑高6.35 180度 Y型
APPROVE		Customer No.	

# Specifications

备注(Remark)

1. 材料(MATERIAL)

胶芯: PA6T/PBT+30%G.F UL94V-0, 颜色: 黑色.

Housing: PA6T/PBT+30%G.F UL94V-0, Color: Black

端子: 磷/青铜, 镍底30u"MIN, 表面镀金u"MIN

Contact: Phosphor bronze, 1u"MIN GOLD PLATING OVER ALL  
30u" MIN NICKEL UNDERPLATING OVER ALL

2. 特性 (characteristics):

额定电流: 2 AMP

Rating Current: 2 AMP.

接触阻抗: 20 mΩ MAX.

Contact Resistance: 20 mΩ MAX.

绝缘阻抗: 1000 MΩ MIN.

Insulating Resistance: 1000 MΩ MIN.

耐电压: AC 500V.

Withstanding Voltage: AC 500V.

温度范围: -40°C to +105°C

Temperature Range: -40°C to +105°C

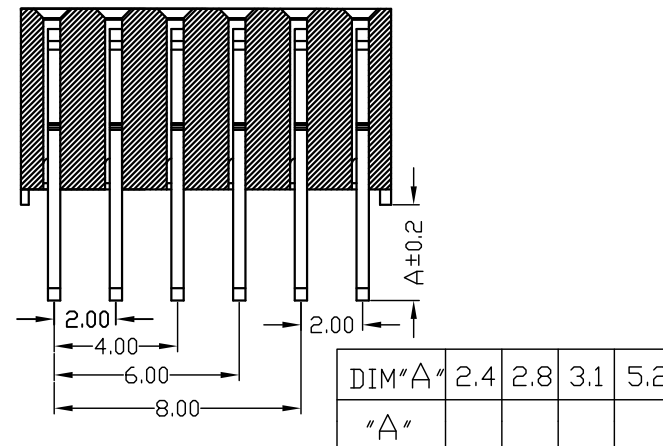
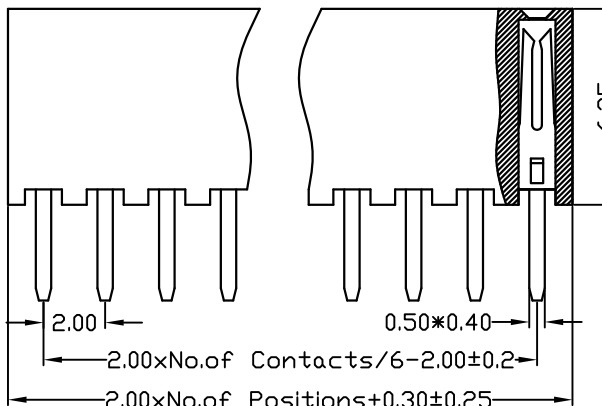
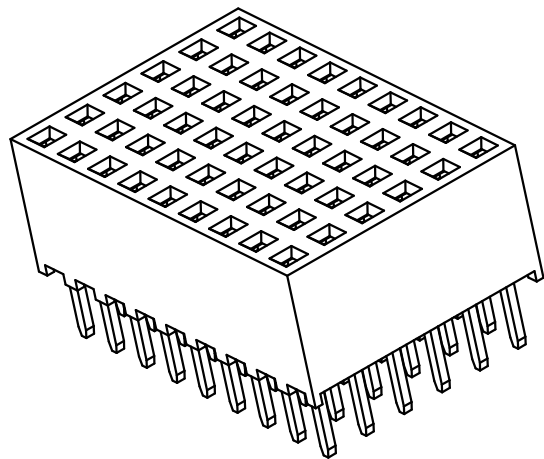
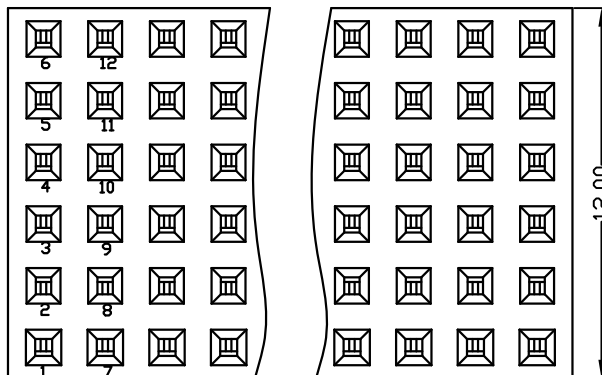
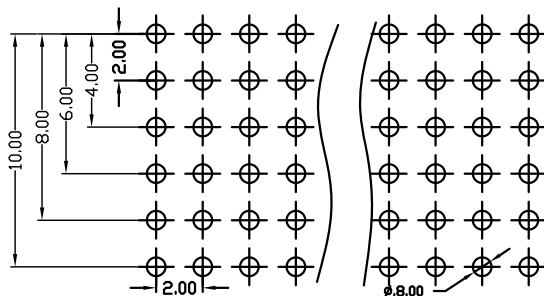

# Ordering Information

F263-16 XX XX X SY

NO. OF PINS PER ROW 6-40P	Contact Plating		INSULATOR MATERIAL: A: PBT B: PA6T C: PA9T D: LCP	PACKING A: PE Bag B: Tape & Reel C: Tube D: Tube+CAP E: Tray
	Full Of Gold	Semi-gold		
A0=0.8u"	B0=0.8U"	A: PBT	B: Tape & Reel	
A1=1u"	B1=1U"	B: PA6T	C: Tube	
A2=1.5u"	B2=1.5U"	C: PA9T	D: Tube+CAP	
A3=2u"	B3=2U"	D: LCP	E: Tray	
A4=3u"	B4=3U"			
A5=5u"	B5=5U"			
A6=10u"	B6=10U"			
A7=15u"	B7=15U"			
A8=20u"	B8=20U"			
A9=30u"	B9=30U"			
	S1=Ordinary Tin Plated			
	S2=Matte Tin Plated			
	S3=Tin-plated High-temperature			

REV	DATE	MODIFICATION DESCRIPTION	CHANGE	APPROVE	DIM	TOL	OPERATION	SCALE	Fit
							X.X	UNIT	MM
							X.XX	SIZE	A4
							X.XXX	SHEET	1/1
							Angle	PROJ.	APPROVE
							±0.25	DESIGN	卢小强
							±0.20	CHECK	PART NO.
							±0.10	APPROVE	F263-16XXXXXXSYX1
							±3°		TITLE:
									2.0mm 排母 六排 塑高6.35 180度 Y型

上海高霖电子有限公司

DESIGN	卢小强	PART NO.	F263-16XXXXXXSYX1
CHECK		TITLE:	2.0mm 排母 六排 塑高6.35 180度 Y型
APPROVE		Customer No.	

# Specifications

备注(Remark)

1. 材料(MATERIAL)

胶芯: PA6T/PBT+30%G.F UL94V-0, 颜色: 黑色.

Housing: PA6T/PBT+30%G.F UL94V-0, Color: Black

端子: 磷/青铜, 镍底30u"MIN, 表面镀金u"MIN

Contact: Phosphor bronze, 1u"MIN GOLD PLATING OVER ALL  
30u" MIN NICKEL UNDERPLATING OVER ALL

2. 特性 (characteristics):

额定电流: 2 AMP

Rating Current: 2 AMP.

接触阻抗: 20 mΩ MAX.

Contact Resistance: 20 mΩ MAX.

绝缘阻抗: 1000 MΩ MIN.

Insulating Resistance: 1000 MΩ MIN.

耐电压: AC 500V.

Withstanding Voltage: AC 500V.

温度范围: -40°C to +105°C

Temperature Range: -40°C to +105°C

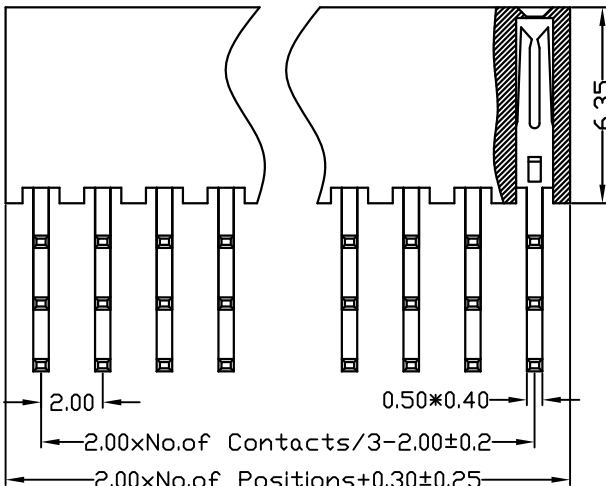
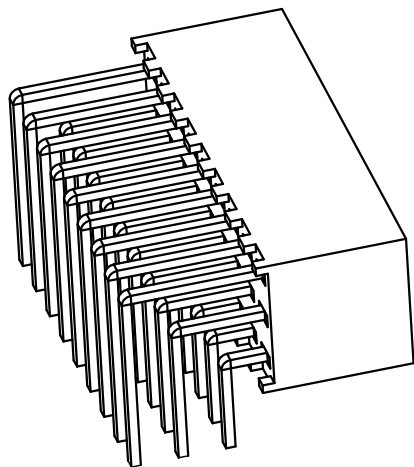
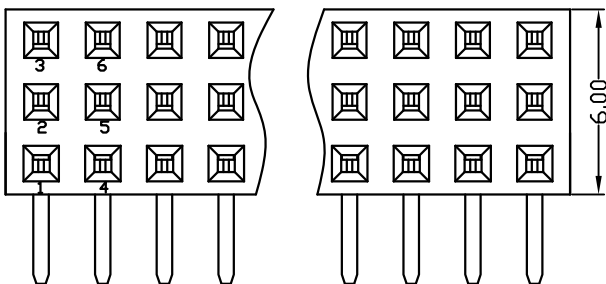
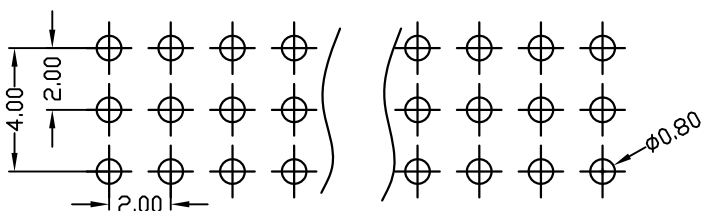

# Ordering Information

F263-13 XX XX X RY

NO. OF PINS PER ROW 3-40P	Contact Plating	INSULATOR	PACKING
	Full Of Gold	MATERIAL:	A: PE Bag
	Semi-gold	A: PBT	B: Tape & Reel
A0=0.8u"	B0=0.8U"	B: PA6T	C: Tube
A1=1u"	B1=1U"	C: PA9T	D: Tube+CAP
A2=1.5u"	B2=1.5U"	D: LCP	E: Tray
A3=2u"	B3=2U"		
A4=3u"	B4=3U"		
A5=5u"	B5=5U"		
A6=10u"	B6=10U"		
A7=15u"	B7=15U"		
A8=20u"	B8=20U"		
A9=30u"	B9=30U"		
	S1=Ordinary Tin Plated		
	S2=Matte Tin Plated		
	S3=Tin-plated High-temperature		

上海高霖电子有限公司

						OPERATION	SCALE	Fit	上海高霖电子有限公司	
						X.X ±0.25	UNIT	MM		
						X.XX ±0.20	SIZE	A4	DESIGN	卢小强
						X.XXX ±0.10	SHEET	1/1	CHECK	PART NO.
						Angle ±3°	PROJ.	APPROVE	TITLE:	F263-13XXXXXRYX1
REV	DATE	MODIFICATION DESCRIPTION		CHANGE	APPROVE	DIM	TOL		Customer No.	2.0mm 排母 三排 塑高6.35 90度 Y型

