

Specifications

备注(Remark)

1. 材料(MATERIAL)

胶芯: PA6T+30%G.F UL94V-0, 颜色: 黑色

Housing: PA6T+30%G.F UL94V-0, Color: Black

端子: 磷/青铜, 镍底30u"MIN, 表面镀金u"MIN

Contact: Phosphor bronze, 1u"MIN GOLD PLATING OVER ALL
30u" MIN NICKEL UNDERPLATING OVER ALL

2. 特性 (characteristics):

额定电流: 2 AMP

Rating Current: 2 AMP.

接触阻抗: 20 mΩ MAX.

Contact Resistance: 20 mΩ MAX.

绝缘阻抗: 1000 MΩ MIN.

Insulating Resistance: 1000 MΩ MIN.

耐电压: AC 500V.

Withstanding Voltage: AC 500V.

温度范围: -40°C to +105°C

Temperature Range: -40°C to +105°C

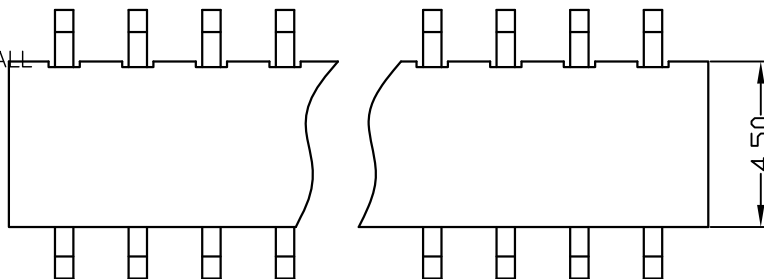

Ordering Information

F220-11 XX XX X MU

NO. OF PINS PER ROW 1~40P	Contact Plating	INSULATOR MATERIAL:	PACKING
A0=0.8u"	Full Of Gold	B: PA6T	A: PE Bag
A1=1u"	Semi-gold	C: PA9T	B: Tape & Reel
A2=1.5u"	B0=0.8U"	D: LCP	C: Tube
A3=2u"	B1=1U"		D: Tube+CAP
A4=3u"	B2=1.5U"		E: Tray
A5=5u"	B3=2U"		
A6=10u"	B4=3U"		
A7=15u"	B5=5U"		
A8=20u"	B6=10U"		
A9=30u"	B7=15U"		
	B8=20U"		
	B9=30U"		
	S1=Ordinary Tin Plated		
	S2=Matte Tin Plated		
	S3=Tin-plated High-temperature		

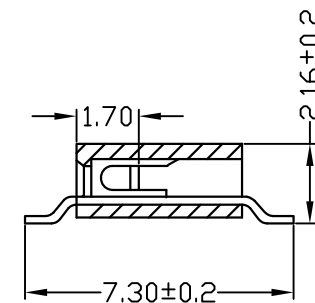
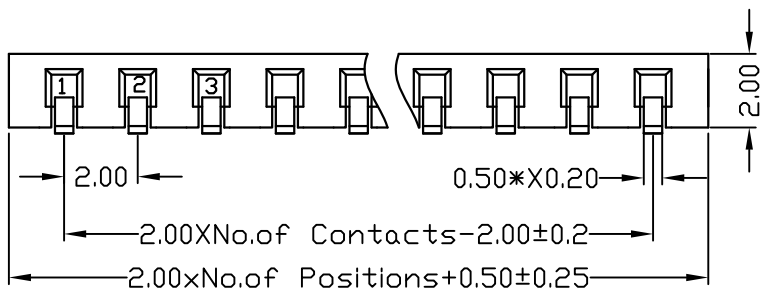
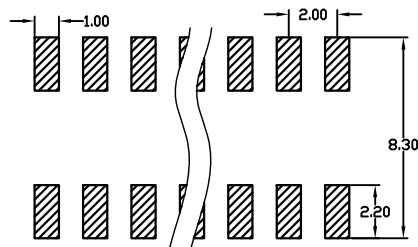

				OPERATION		SCALE		Fit		上海高霖电子有限公司	
				X.X	±0.25	UNIT		MM			
				X.XX	±0.20	SIZE	A4	DESIGN	卢小强	PART NO.	F220-11XXXXXMUX1
				X.XXX	±0.10	SHEET	1/1	CHECK		TITLE:	2.00mm 单排母 塑高2.0 SMT U型
REV	DATE	MODIFICATION DESCRIPTION		CHANGE	APPROVE	DIM	TOL	PROJ.	APPROVE	Customer No.	

Specifications

备注(Remark)

1. 材料(MATERIAL)

胶芯: PA6T+30%G.F UL94V-0, 颜色: 黑色

Housing: PA6T+30%G.F UL94V-0, Color: Black

端子: 磷/青铜, 镍底30u"MIN, 表面镀金u"MIN

Contact: Phosphor bronze, 1u"MIN GOLD PLATING OVER ALL
30u" MIN NICKEL UNDERPLATING OVER ALL

2. 特性 (characteristics):

额定电流: 2 AMP

Rating Current: 2 AMP.

接触阻抗: 20 mΩ MAX.

Contact Resistance: 20 mΩ MAX.

绝缘阻抗: 1000 MΩ MIN.

Insulating Resistance: 1000 MΩ MIN.

耐电压: AC 500V.

Withstanding Voltage: AC 500V.

温度范围: -40°C to +105°C

Temperature Range: -40°C to +105°C

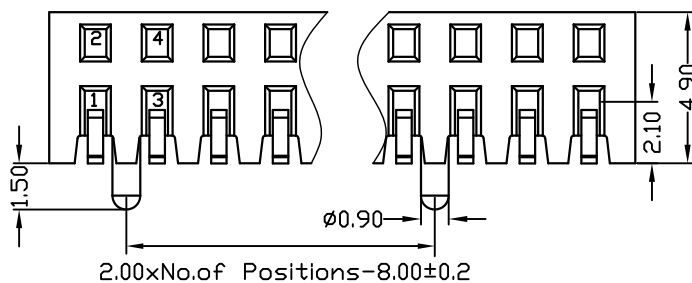
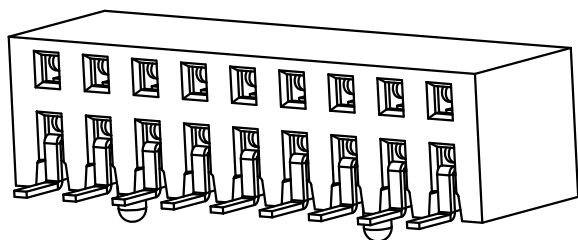
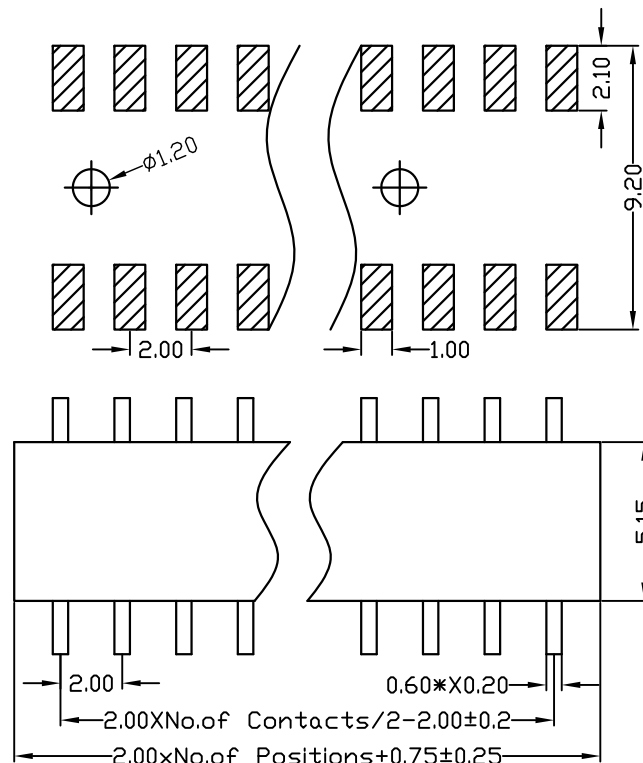

Ordering Information

F249-12 XX XX X MU

NO. OF PINS PER ROW 2~40P	Contact Plating	INSULATOR	PACKING
	Full Of Gold	Semi-gold	MATERIAL:
A0=0.8u"	B0=0.8U"	B:PA6T	A:PE Bag
A1=1u"	B1=1U"	C:PA9T	B:Tape & Reel
A2=1.5u"	B2=1.5U"	D:LCP	C:Tube
A3=2u"	B3=2U"		D:Tube+CAP
A4=3u"	B4=3U"		E:Tray
A5=5u"	B5=5U"		
A6=10u"	B6=10U"		
A7=15u"	B7=15U"		
A8=20u"	B8=20U"		
A9=30u"	B9=30U"		
	S1=Ordinary Tin Plated		
	S2=Matte Tin Plated		
	S3=Tin-plated High-temperature		

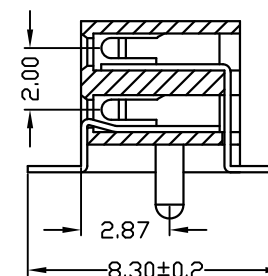

REV	DATE	MODIFICATION DESCRIPTION	CHANGE	APPROVE	DIM	TOL	OPERATION	SCALE	Fit	上海高霖电子有限公司			
							X.X ±0.25	UNIT	MM				
							X.XX ±0.20	SIZE	A4	DESIGN	卢小强	PART NO.	F249-12XXXXXXMUX2
							X.XXX ±0.10	SHEET	1/1	CHECK		TITLE:	2.00mm 双排母 塑高4.9 U型 SMT 带柱 侧插
							Angle ±3°	PROJ.		APPROVE		Customer No.	

Specifications

备注(Remark)

1. 材料(MATERIAL)

胶芯: PA6T+30%G.F UL94V-0, 颜色: 黑色

Housing: PA6T+30%G.F UL94V-0, Color: Black

端子: 磷/青铜, 镍底30u"MIN, 表面镀金u"MIN

Contact: Phosphor bronze, 1u"MIN GOLD PLATING OVER ALL
30u" MIN NICKEL UNDERPLATING OVER ALL

2. 特性 (characteristics):

额定电流: 2 AMP

Rating Current: 2 AMP.

接触阻抗: 20 mΩ MAX.

Contact Resistance: 20 mΩ MAX.

绝缘阻抗: 1000 MΩ MIN.

Insulating Resistance: 1000 MΩ MIN.

耐电压: AC 500V.

Withstanding Voltage: AC 500V.

温度范围: -40°C to +105°C

Temperature Range: -40°C to +105°C

Ordering Information

F249-12 XX XX X MU

NO. OF PINS PER ROW 2~40P	Contact Plating Full Of Gold	Semi-gold	INSULATOR MATERIAL:	PACKING
A0=0.8u"	B0=0.8U"	B:PA6T	A:PE Bag	
A1=1u"	B1=1U"	C:PA9T	B:Tape & Reel	
A2=1.5u"	B2=1.5U"	D:LCP	C:Tube	
A3=2u"	B3=2U"		D:Tube+CAP	
A4=3u"	B4=3U"		E:Tray	
A5=5u"	B5=5U"			
A6=10u"	B6=10U"			
A7=15u"	B7=15U"			
A8=20u"	B8=20U"			
A9=30u"	B9=30U"			
	S1=Ordinary Tin Plated			
	S2=Matte Tin Plated			
	S3=Tin-plated High-temperature			

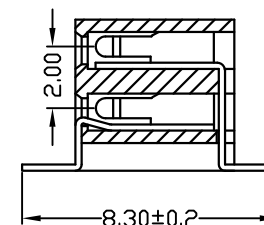
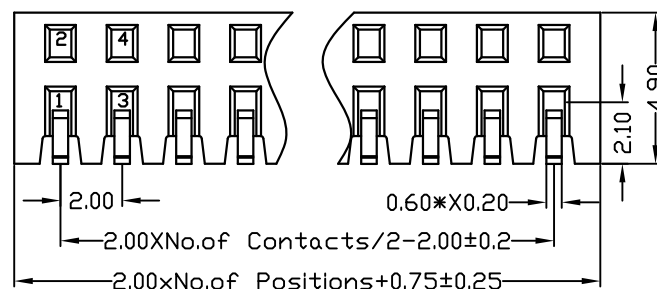
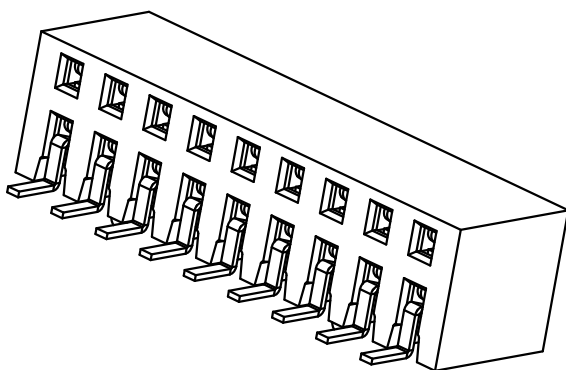
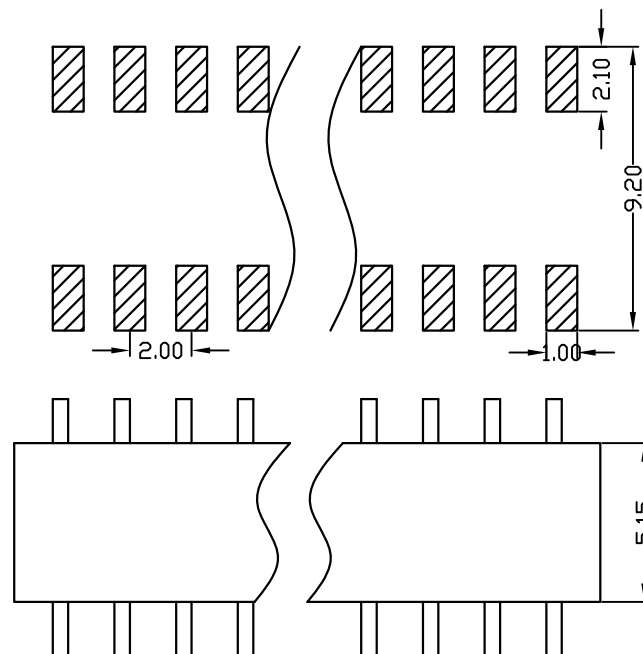

				OPERATION		SCALE		Fit		上海高霖电子有限公司	
				X.X	±0.25	UNIT		MM			
				X.XX	±0.20	SIZE	A4	DESIGN	卢小强	PART NO.	F249-12XXXXXMUX1
				X.XXX	±0.10	SHEET	1/1	CHECK		TITLE:	2.00mm 双排母 塑高4.9 SMT U型 侧插
				Angle	±3°	PROJ.	☉	APPROVE		Customer No.	
REV	DATE	MODIFICATION DESCRIPTION		CHANGE	APPROVE	DIM	TOL				